

PEAKTRONICS

EXE-100

Actuator Controls External Enclosure

The Peaktronics EXE-100 NEMA 4 rated External Enclosure is ideal for adding advanced controls (positioners, timers, etc.) to small actuators. The package comes with a subpanel and hardware for easy mounting of Peaktronics actuator controls (see below).

ASSEMBLY DIAGRAM - standard controller

ASSEMBLY DIAGRAM - miniature controller

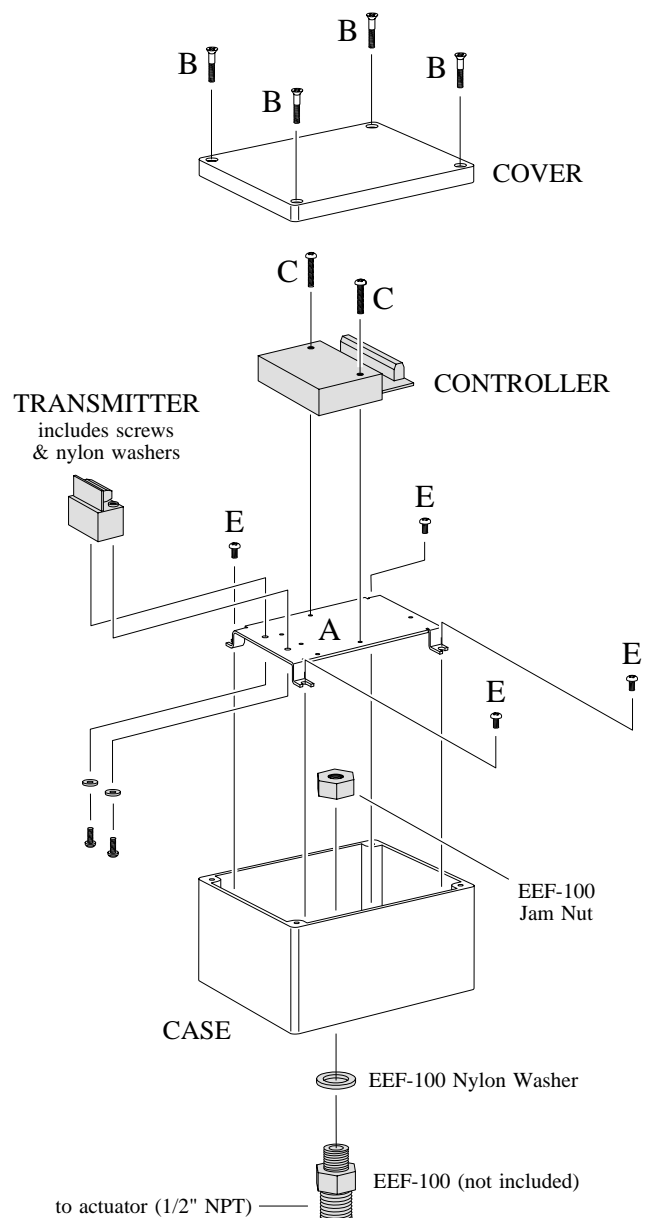
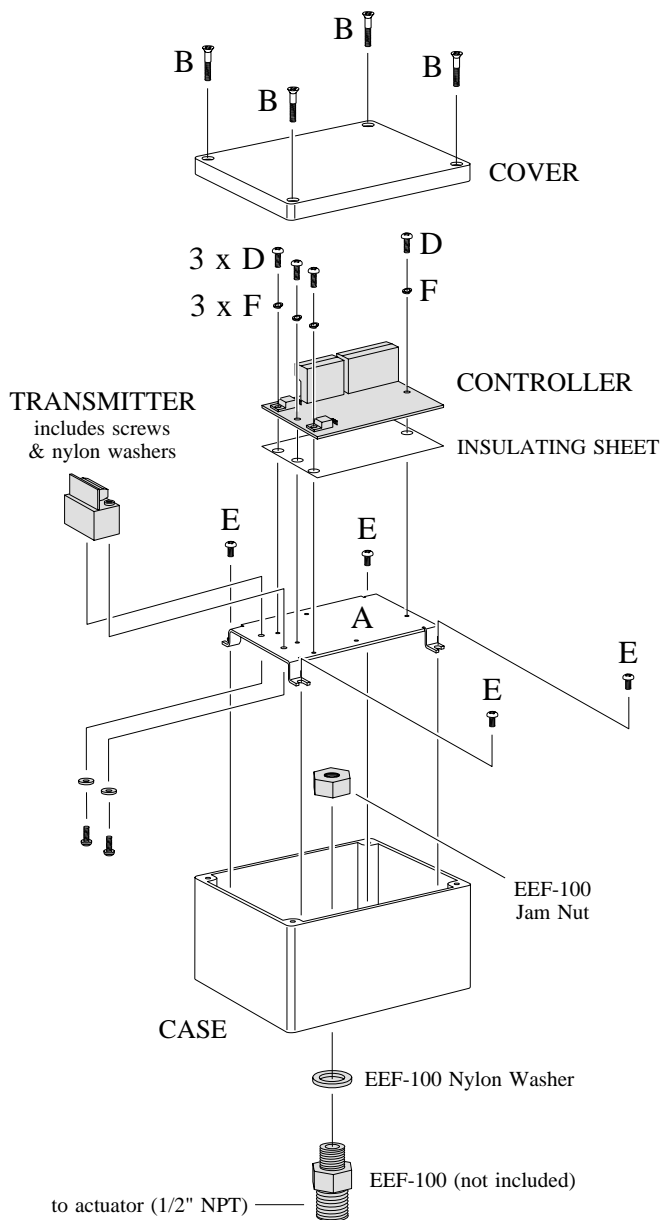

PACKAGE CONTENTS

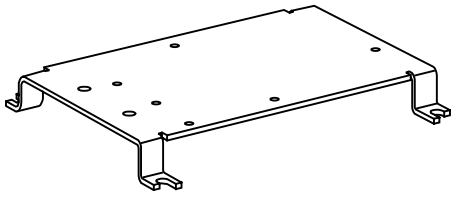

A

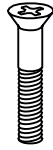

B

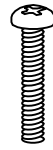

C



D



E



F

ITEM	QTY	DESCRIPTION
A	1	subpanel
B	4	cover screws
C	2	#6-32 x 0.75" pan head screw
D	4	#6-32 x 0.375" pan head screw
E	4	#6-32 x 0.312" self-tapping pan head screw
F	4	#6 split ring lockwasher

OUTLINE

